

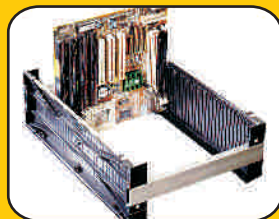

ALKON[®]
ESD SAFE PRODUCTS

Electrostatic
Discharge
Protection



www.alkonplastics.com

CAT.- 2011-B



CONDUCTIVE



ESD

PROTECT ELECTRO STATIC SENSITIVE DEVICES ABOUT ELECTROSTATIC DISCHARGE (ESD)

To a greater or lesser extent all contact between objects, every separation of one item from another, each sliding of one thing on another, causes a disturbance of electrical charge. When charge disturbance take place faster than charge redistribution, static charge accumulates. ESD occurs where charges of different electrostatic potentials meet. The flow of electrons is usually sudden and releases energy that can damage electrostatic sensitive devices (ESDs)

This is referred to as tribo electric generations.

Static charges of upto 30000 volts are not uncommon and can be generated by the simple act of walking across a floor, yet a discharge of only 10 volts can destroy a class 1 ESD sensitive device.

A material that inhibits the generation of tribo electric generation is classified as anti static. An anti static material can be conductive (10^3 - 10^5 ohms/sq), static dissipative (10^6 - 10^9 ohms/sq), antistatic (10^{10} - 10^{12} ohms/sq) or even insulative (greater than 10^{12} ohms/sq)

Only conductive or static dissipative anti static material should be used in ESD protected areas .

10^3 10^4 10^5 CONDUCTIVE	10^6 10^7 10^8 10^9 STATIC DISSIPATIVE	10^{10} 10^{11} 10^{12} ANTI STATIC	10^{13} INSULATIVE
---	--	---	--------------------------------

ALKON uses special blended imported raw material to produce permanent **ESD** Safe Products like different sizes of bins, trays, containers, component organizers, cabinets, PCB carriers, Component Shelving System etc.



PCB CARRIERS

ALKON introduces a wide range of fixed and adjustable PCB Carriers to stack and store or transport your PCB's. They are the most modern designed carriers available. They are manufactured in both Conductive and Non-conductive plastic and can handle all sizes of PCB's.

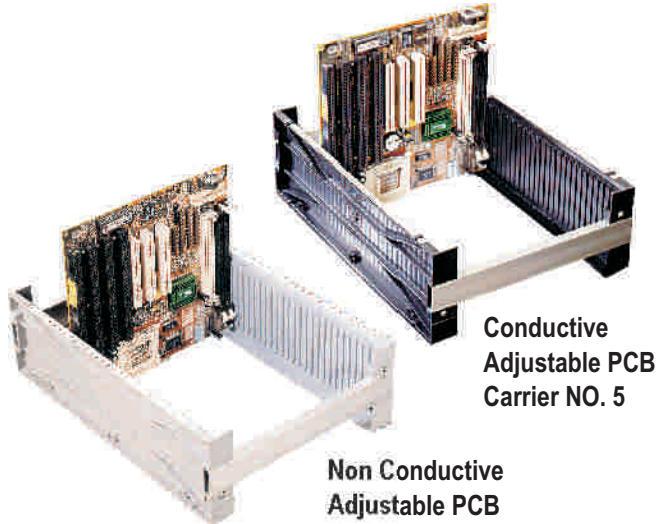

**Conductive
Adjustable PCB
Carrier NO. 5**

**Non Conductive
Adjustable PCB
Carrier NO.5**

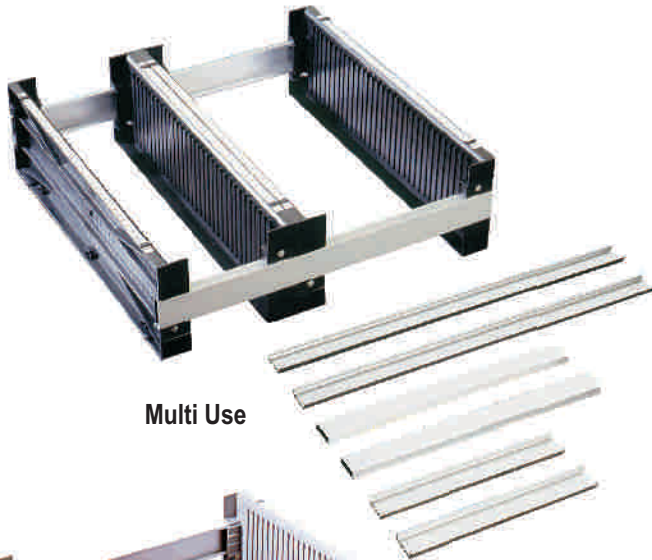

Multi Use

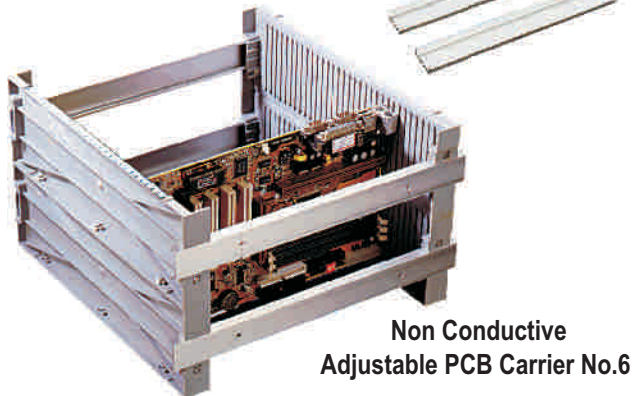

**Non Conductive
Adjustable PCB Carrier No.6**

CONDUCTIVE AND NON CONDUCTIVE ADJUSTABLE PCB CARRIERS

ALKON adjustable PCB Carriers can be used for protection of boards during storage or transport in assembly line or integrate with automatic component insertion machines. They can be stacked one on each other. Each PCB Carrier has distinctly numbered on white background, 31 slots which can hold a maximum of 31 PCB's. Special Aluminium Guides have a unique design which remains Flush with PCB Carriers. They help in adjusting the width as per the Size of PCB,s Three lengths of aluminium guides are available i.e. 253 mm, 353mm and 553mm

ADJUSTABLE PCB CARRIER NO.: 5

Useful for small to medium Boards

Size of sides 350mm x 105mm

Use different size of Aluminium guides to make the configuration as per the size of PCB.

Conductive Adjustable PCB Carrier NO.: 5

Set of 2 pcs. - Colour Black

Art No.: **APCR5 - C**

Non Conductive Adjustable PCB Carrier NO.: 5

Set of 2 pcs. - Colour Grey

Art No.: **APCR5 - N**

Order aluminium guides separately.

MULTI USE

Different sizes of PCB's can be fitted in two PCB Carriers as shown in the picture

ALUMINIUM GUIDES

Three Standard lengths Aluminium anodized guides are available Longer lengths useful for handling different sizes of PCB's are available on request.

LENGTH

253 mm Set of 2 pcs. Art No.: **APCRG -2**

353 mm Set of 2 pcs. Art No.: **APCRG -3**

553 mm Set of 2 pcs. Art No.: **APCRG -5**

ADJUSTABLE PCB CARRIER NO.: 6

Useful for medium sized Boards

Size of sides 350 mm x 210 mm

2 Sets of Aluminium guides are required for Carrier No. 6

Conductive Adjustable PCB Carrier No.: 6

Set of 2 pcs. - Colour Black .

Art No.: **APCR6 - C**

Non Conductive Adjustable PCB Carrier No.: 6

Set of 2 pcs. - Colour Grey .

Art No.: **APCR6 - N**

Order Aluminium guides separately.



PCB CARRIERS



Non Skid Fitting

NON SKID FITTING

Non Skid fitting available to fit at the bottom on Aluminum guides to keep the PCB carriers at a taper for horizontal storage of PCB's.

Set of- 2 pcs.

Art No.: **NSF**

CARRY HANDLE

Carry handle can be provided to carry the PCB's in horizontal position in the racks.

Handle 1 pc.

Art No.: **PCB-H**

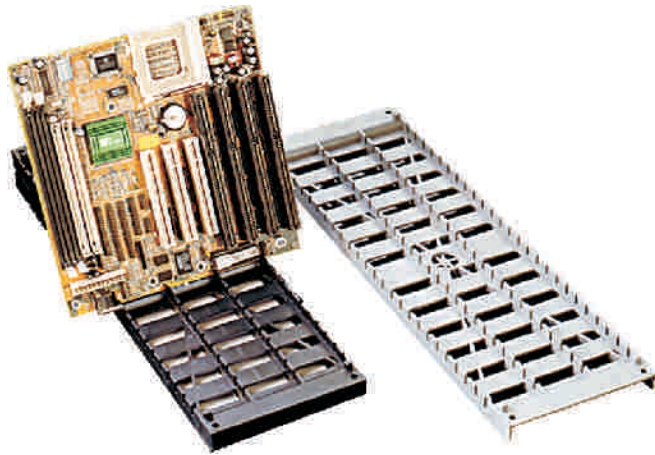

Conductive & Non Conductive
Fixed PCB Carriers

CONDUCTIVE & NON CONDUCTIVE FIXED PCB CARRIERS

Economical carriers for handling clinched SMD's, Soldered or bare boards of any Size.

Tapered slots to keep PCB's in taper position.

Easy to carry.

Size 458 mm x 140 mm

25 Slots

Black Colour for conductive. Art No.: **APCR1-C**

Grey Colour for non conductive. Art No.: **APCR1-N**

Packing : Fixed PCB Carrier are packed 5 pcs. in a box.

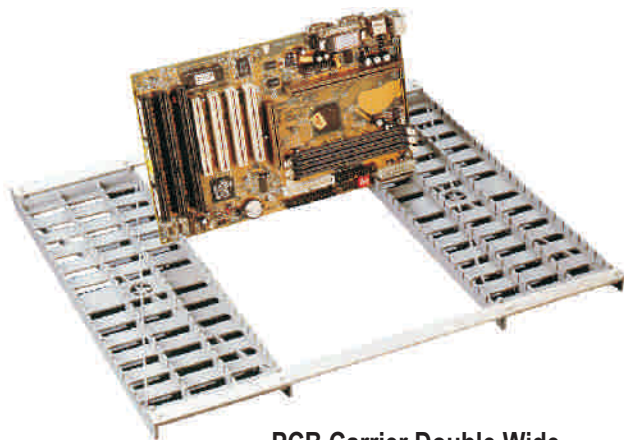

PCB Carrier Double Wide

PCB CARRIER DOUBLE WIDE

Two PCB Carriers can be connected with Aluminium connectors for very wide PCB's upto 600mm.

Conductive :

Art No.: **APCR 1-WC**

Non Conductive :

Art No.: **APCR 1-WN**



FIXED PCB CARRIERS - L TYPE



Art No.: **APCR 4 - C**
(Conductive Black)

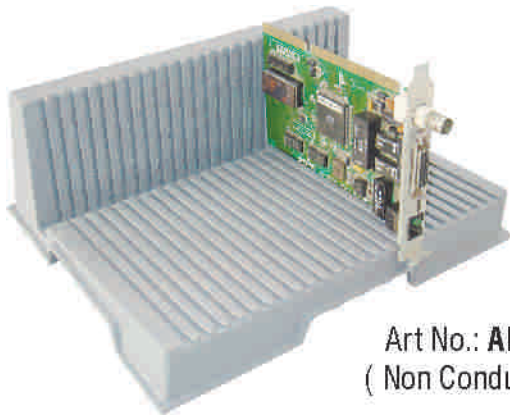

Art No.: **APCR 4 - N**
(Non Conductive Grey)

It is a two side support PCB carrier of conductive or non conductive material for stronger card holding. Conductive PCB carrier are excellent PCB carrier for work benches. Easy to handle and does not occupy much space. Electrically conductive models are wholly earthed only by placing them on an earthed table.

- ▶ Holds boards on two contiguous edges.
- ▶ Nestable when not in use.
- ▶ Conductive PCB carrier in Black colour.
- ▶ Non conductive PCB carriers in Grey colour.
- ▶ Size : 207 x 273 x 95 mm.
- ▶ 25 grooves, 9mm Pitch, 3mm width.

CONDUCTIVE COMPONENT ORGANISER



Conductive Component Organiser

COMPONENT ORGANISER

Conductive Component Organiser provides systematic storage of electrostatic sensitive devices. It consists of a cabinet with 25 small drawers.

Size of Cabinet: 400mm x 250mm x 160mm

Size of the Drawers: 150mm x 75mm x 35mm.

Non Conductive Component Organisers are also available

Art No.: **ACO 25 - C Conductive**

Art No.: **ACO 25 Nonconductive**



MODULAR SYSTEM-CONDUCTIVE

Modular system is an ideal storage system for Electrostatic sensitive devices based on standard modules which can be interlocked and stacked one on top of each other.

The basic system is around four drawer sizes

which can be interchanged in the ratio of : 1 : 2: 3: 4.

All cabinets can be supplied with / without central lock.





MODULAR SYSTEM-CONDUCTIVE



SPECIAL STOPPERS

Special stoper is provided to stop the drawers when opened fully. To remove drawer from the cabinet lift the drawer up & remove from cabinet.

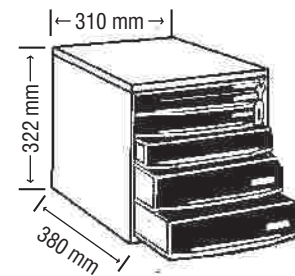
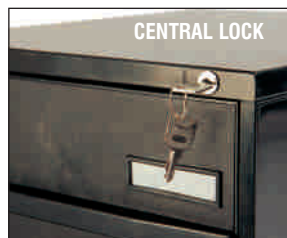

INTERNAL SIZE OF DRAWERS

AD1-C 360 mm x 265 mm x 16 mm
AD2-C 360 mm x 265 mm x 39 mm
AD3-C 360 mm x 265 mm x 62 mm
AD4-C 360 mm x 265 mm x 87 mm
AMS12-C Modular system with 12 AD1-C Drawers
AMS6-C Modular system with 6 AD2-C Drawers
AMS4-C Modular System with 4 AD3-C Drawers
AMS3-C Modular System with 3 AD4-C Drawers

MIXED DRAWER SYSTEM

Modular System can be fitted with different size of drawers in the same cabinet. For example, One AD4-C drawers can be replaced by two AD2-C drawer or one AD1-C drawer and one AD3-C drawer

INDICATOR

Name plate can be changed by pushing out the paper from the indicator as shown.

BASE UNIT

Base unit can be used with casters to make a mobile unit. One or more base unite can be used (Joined by set of four dowels provided) under the Modular system to raise the cabinet from the floor. Height of base unit is 35mm.

CENTRAL LOCKING SYSTEM

Is provided OPTIONALLY. Product numbers for cabinet with locks will be AMS12L-C , AMS6L-C, AMS4L-C etc.

CONDUCTIVE UTILITY CONTAINERS : FOR STORAGE OF SMALL PARTS THREE SIZES OF CONTAINER IN BLACK COLOUR ARE AVAILABLE TO FIT IN AD3-C DRAWERS AND ONE SIZE TO FIT IN AD2-C DRAWER

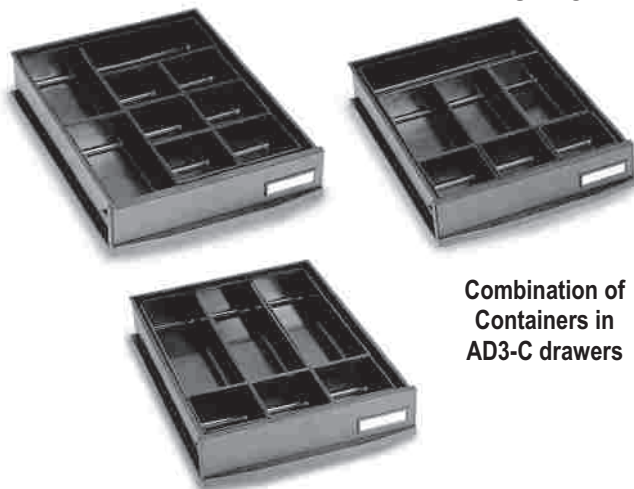

SIZES OF CONTAINERS :

- Art No. UC1-C** Size 82 x 82 x 55 mm
12 CONTAINERS FIT IN ONE AD3-C DRAWER
- Art No. UC2-C** Size 170 x 82 x 55 mm
6 CONTAINERS FIT IN ONE AD3-C DRAWER
- Art No. UC3-C** Size 255 x 82 x 55 mm
4 CONTAINERS FIT IN ONE AD3-C DRAWER
- Art No. UCD 2-C** Size 258 x 85 x 37 mm with 2 partition
6 CONTAINERS FIT IN ONE AD2-C DRAWER
- Art No. UC6-C** Size 95 x 90 x 45 mm
This container is designed to be used in USE ALL BOX



USE ALL BOX CONDUCTIVE

MULTIPURPOSE USE ALL BOX WITH ONE OR TWO DRAWERS

Cabinet : Black conductive Plastic
Size : 215 x 282 x 242

Drawers : Black conductive Plastic

Big Drawer : 195 x 273 x 110 mm

Small Drawer : 195 x 273 x 55 mm.

Multipurpose use all box cabinet can be interlocked both vertically and horizontally. Assemble cabinets from left to right and bottom to top.

ART No.: MUB-1 C with one big drawer

ART No.: MUB- 2 C with two small drawers.

ART No.: UC6-C Conductive Container.

Size : 90 x 95 x 45 mm

6Nos. UC 6-C Containers can fit in one small drawer.

Art No.: MUB-2 CP Vertical Partition.

Two Vertical Partition can fit in one small drawer in the slots provided.

Non Conductive Use all box available :

Cabinet Grey colour. Drawers Transparent

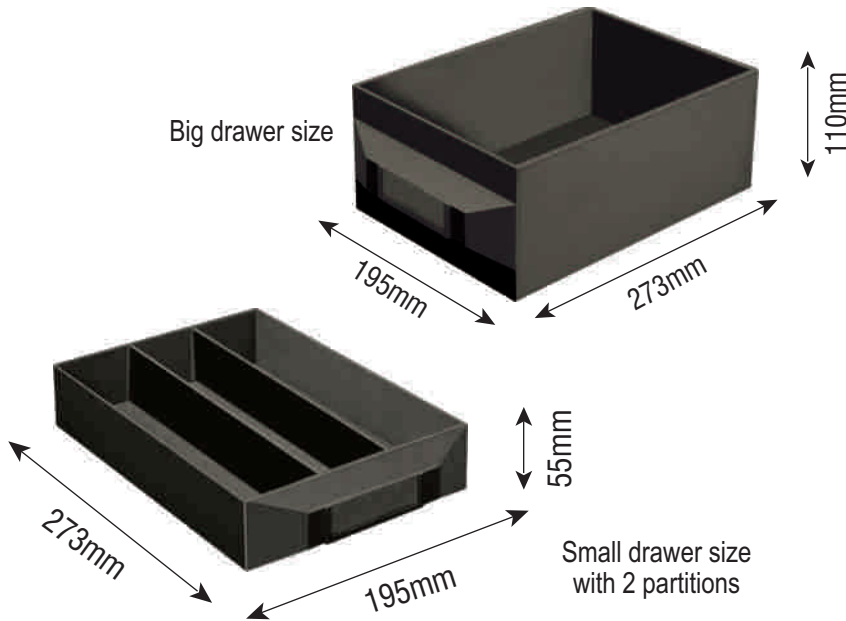

6 nos. Of UC 6-C Containers can fit in one small drawer.

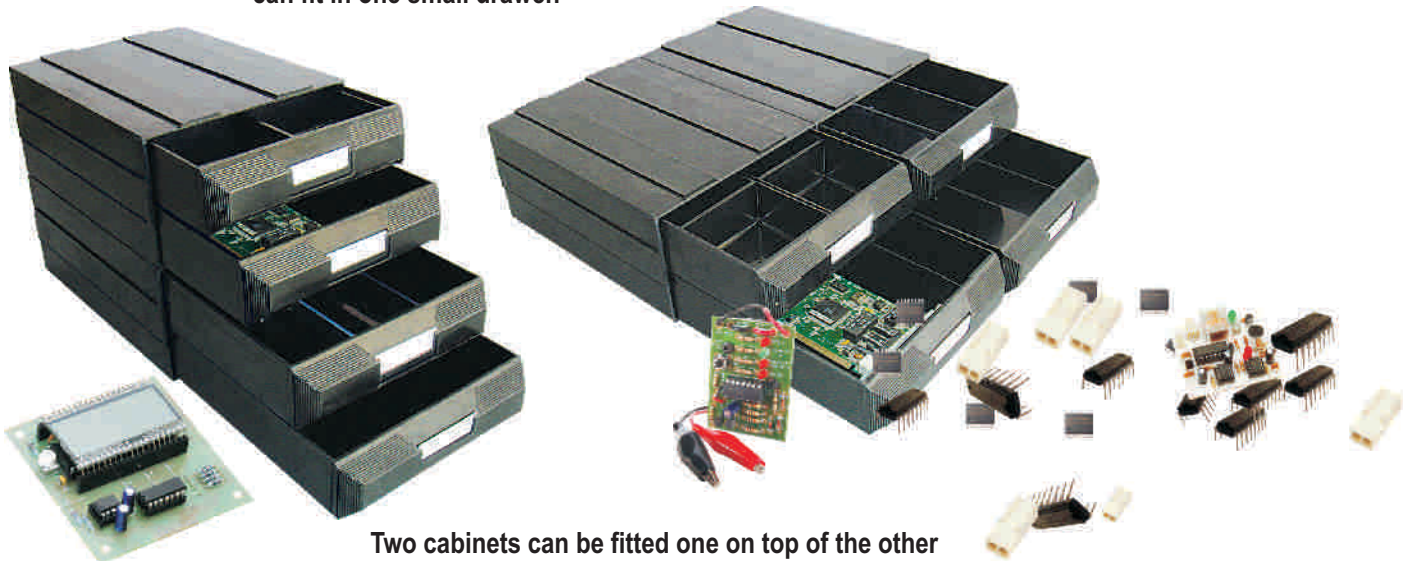

Two cabinets can be fitted one on top of the other or side by side as shown above.



SUPRA BINS CONDUCTIVE

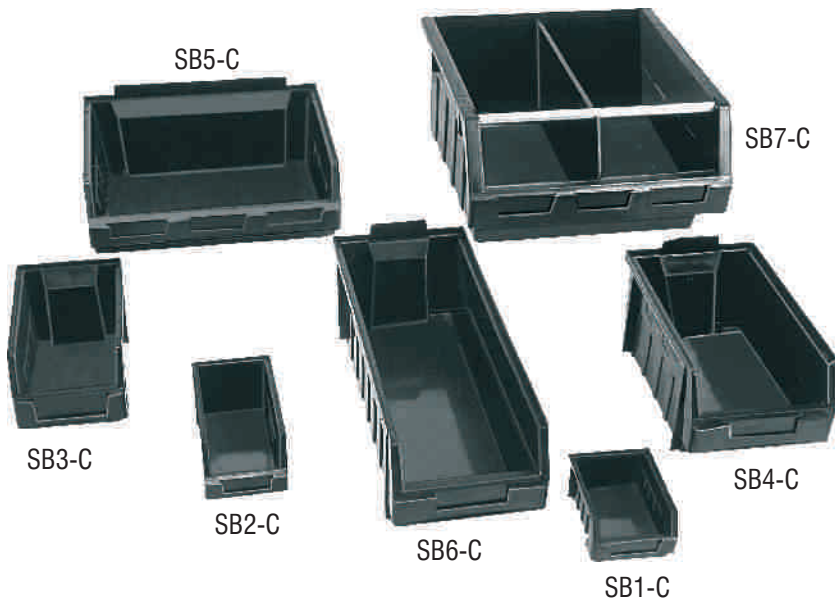

SUPRA BIN PARTITIONS

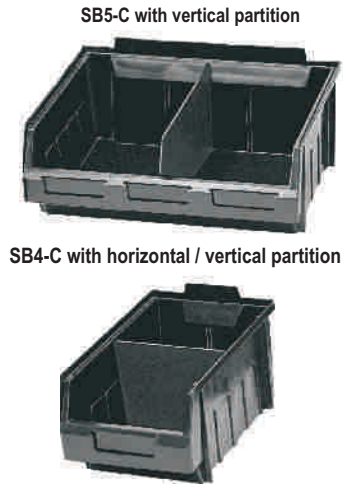

Horizontal partition for SB4-C & SB6-C
 Art No.: **HP SB4-C / HP SB6-C**
 Vertical partition for SB4-C & SB5-C
 Art No.: **VP SB4-C / VP SB5-C**
 Vertical partition for SB6-C Art No.: **VP SB6-C**
 Vertical partition for SB7-C Art No.: **VP SB7-C**

Supra Bins Dimensions in mm

Art No.	A	B	C
SB1-C	125	100	60
SB2-C	170	100	85
SB3-C	220	130	125
SB4-C	290	178	143
SB5-C	290	363	145
SB6-C	440	180	145
SB7-C	435	400	215

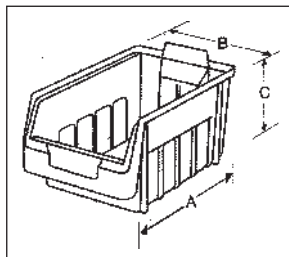

Made from Conductive Polypropylene. Strong rear lip for use with louvred panels. Strong heavy duty, with reinforced base side & stacking rim. Resistant to most industrial solvents, withstands higher temperatures. Clear access to contents. All bins with identification card holder slots. Incorporates a safety stop feature in SB 4-C, SB 5-C, SB 6-C, at the back for use in shelves. Colour - BLACK.

STACKING

Supra Bins are designed to be stacked one on top of each other.

LOUVRE PANELS

They are made from 1.5mm CRCA steel and are powder coated in grey colour. They come in four sizes. They can be fitted on walls or on stand on table with our special stands.

Art No.: **SBLP1** Size 457 mm X 457mm

Art No.: **SBLP2** Size 457mm X 610mm

Art No.: **SBLP3** Size 457mm X 915mm

Art No.: **SBLP6** Size 457mm X 1830mm

Different Types of Stands & Trolleys are available.

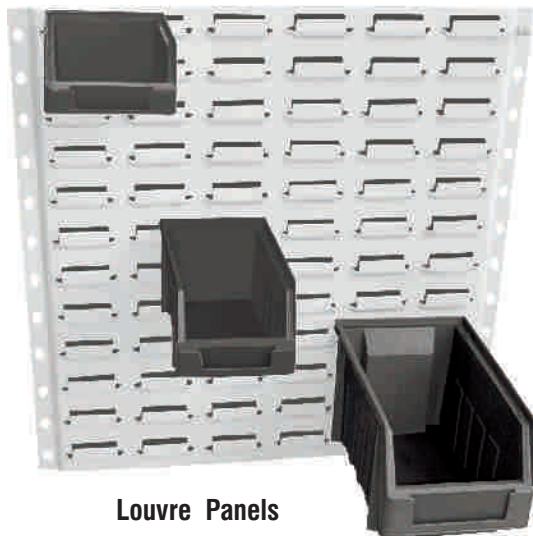

Louvre Panels



HINGED BOXES



APPBM-C



APPBS-C



APSB-C



ATBS-C

CONDUCTIVE / NONCONDUCTIVE HINGED BOXES SMALL SIZE

Two Sizes of hinged boxes are available in conductive and nonconductive Black Colour with conductive foam. Ideal for shipping and long term storage of sensitive devices with foam acting as a cushioning material for components.

1) Small Box: Size 180mm x 95mm x 22mm

Art No.: **APPBS-C** Conductive

Art No.: **APPBS** Nonconductive

2) Medium Box: Size 190mm x 120mm x 40mm

Art No.: **APPBM -C** Conductive

Art No.: **APPBM** Nonconductive

BIG BOX WITH FOAM

Big size box with cover available in conductive and nonconductive plastic with foam inside for protection of all sensitive devices.

Size: 333mm x 133mm x 40mm

Art No.: **APSB -C** Conductive

Art No.: **APSB** Nonconductive

AL BOX CONDUCTIVE HINGED BOX WITH HANDLE & LOCKING FACILITY

Big Size hinged box is very useful for storage and transport of delicate electronic device which can also be locked. Alternatively it can be used as a tool box. It has a small parts tray inside the box.

Size of Box: 280mm x 125mm x 95mm

Art No.: **ATBS - C** Conductive

Art No.: **ATBS** NonConductive

CONDUCTIVE WASTE PAPER BIN



- ▶ Excellent conductive waste paper bin for use in clean rooms.
- ▶ Made from conductive polypropylene.

Art No.: **AWPBS-C**

Size	Top Dia	Bot. Dia	Height
Small	210 mm	170 mm	240 mm

CONDUCTIVE FOAM



Ideal for long term storage of critical devices as it is low charging and conductive. Will protect the long term solderability of device lead as it is corrosion resistant.

Availability : Conductive Hard Foam-6mm
Conductive Soft Foam-10mm



ESD WORKSTATION



Art No.: AWS12060



Art No.: AWS12060 SP

Today's electronic manufacturers need a workstation designed to help reduce harmful discharges from reaching vulnerable parts and assemblies. Part of the overall solution is to have a workstation designed with the proper grounding system to dissipate any charge away from the product you're producing. Our custom made workstations are designed to withstand the toughest of environments, allow total flexibility for future upgrades and meet your organization's ESD needs.

Available in Standard size

ART NO.	SIZE
AWS 12060	Table Top Size 1200mm X 600mm over all height 1800mm
AWS 12060 SP	Table Top Size 1200mm X 600mm over all height 1500mm

Standard Features

- ▶ Workstation structure made from 20 x 40mm rectangular pipes of 18 Gauge.
- ▶ Available in powder coated grey colour.
- ▶ ESD Mat for table top with grounding cord.
- ▶ Universal spike protector 230V / 50Hz, 15 Amps with four sockets.
- ▶ Four conductive leveling screws for base with height adjustment facility.
- ▶ Foot rest for user convenience

Optional Accessories

- ▶ 28 W flicker free swivel Light.
- ▶ Louver panel.
- ▶ Conductive Bins as required.
- ▶ Writing & Felt Board as per requirement.
- ▶ Tool Tray with option of fitting on Left or Right side.
- ▶ Alkon Modular System with lock. 1 No. as per image above.

Work Station for Non ESD application also available
Special sizes available on request.



ESD SAFE PANDA SHELF BINS



PSB-401C

PSB-402C

PSB-403C

PSB-404C

PSB-405C

MADE FROM CONDUCTIVE POLYPROPYLENE

- ▶ Designed to fit roll post shelving systems.
- ▶ Five standard bin sizes to suit 400 mm deep shelving.
- ▶ Integral back stop for clear viewing of PANDA BIN contents.
- ▶ Dividers are notched to ensure positive location within the bins.
- ▶ PANDA BINS feature a small handle to allow maximum area of the front face for sticking identification labels.
- ▶ The PANDA BINS use a unique design for added strength.

BIN DIMENSIONS

SR NO.	ART NO.	Outer Dimensions			Inner Dimensions			No. Of Dividers with each bin	Effective Height	Std. Pack
		Length	Width	Height	Length	Width	Height			
1.	PSB-401C	415	100	60	393	86	55	3	55	24
2.	PSB-402C	415	100	110	393	86	105	2	105	24
3.	PSB-403C	415	150	110	393	136	105	2	105	12
4.	PSB-404C	415	220	135	393	210	130	2	130	12
5.	PSB-405C	415	300	135	393	282	130	2	130	6

All dimensions in mm Approx



Roll Post Shelving System



Integral back stop allows viewing of contents



Snap-in Divider Fitted in PANDA SHELF BIN

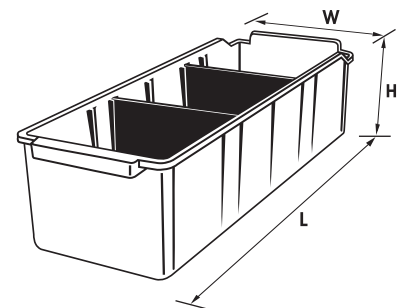



ESD SAFE PANDA SHELVING SYSTEMS

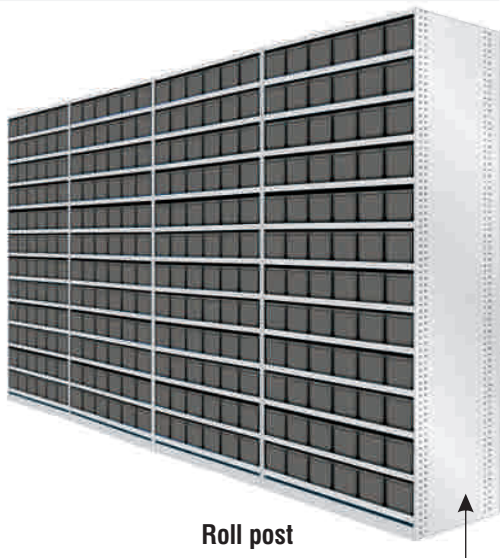

Roll post



Shelf



Kick plate

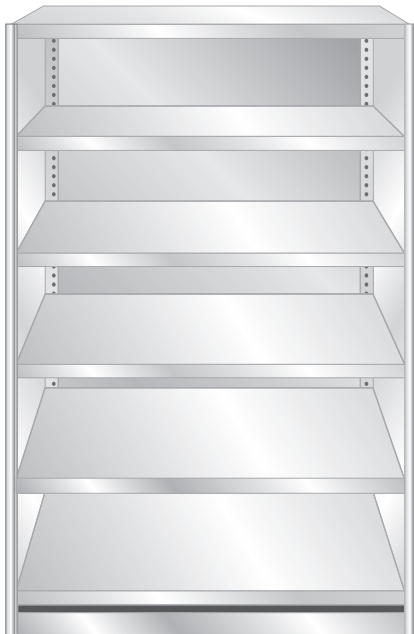

Roll posts

Panda Shelving Systems have one-piece solid uprights with a rolled front edge for additional strength, safety and aesthetic appeal. Roll posts are available in 1875 mm height which is suitable for 400mm deep shelves.

Shelves

Shelf levels are easily adjusted in 25mm increments and are held into position with the use of nuts / bolts. Shelves are available in 400mm depth having 900mm width as standard.

Back plate

Back panel provide additional stability and prevents dust.

Kick plates

All shelving bays are fitted with solid kick plates, which prevent unwanted material to enter inside the base of the shelving unit and It looks aesthetically good.

Flexibility

Panda shelving systems are fully enclosed and are designed to suit your ever changing needs. The flexibility of the product accommodates additions or alterations at any stage, with a minimum of fuss or disruption to your day to day operation.

Finish

All Panda shelving components are manufactured in 0.8mm specially treated steel to make it ESD safe .

**BINS / ROLL POSTS / BACK PLATES / SHELVES
can be ordered separately as per your requirement.**



ESD SAFE PANDA SHELVING SYSTEMS

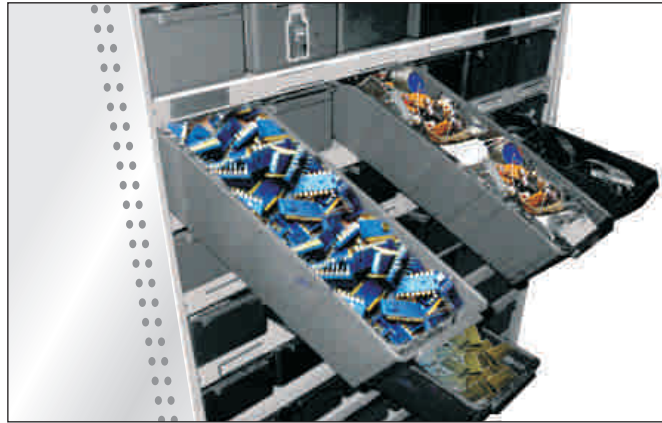

Shelf load Capacity as per the UDL
(UNIFORMLY DISTRIBUTED LOAD)

SHELF	SHELF SIZE IN MM			UDL
	Depth	Width	Height	
ASUS 400C	400	900	30	60 Kg.

All dimensions in mm approx.

STANDARD SIZE

System Depth (mm) 400
System Height (mm) 1875
System Width (mm) 900

BINS / SHELVING BODIES / SHELVES / KICK PLATES can be ordered separately as per your requirement.

ASU 21C

SHELVING UNIT SIZE		
Height	Width	Depth
1875 mm	900 mm	400 mm

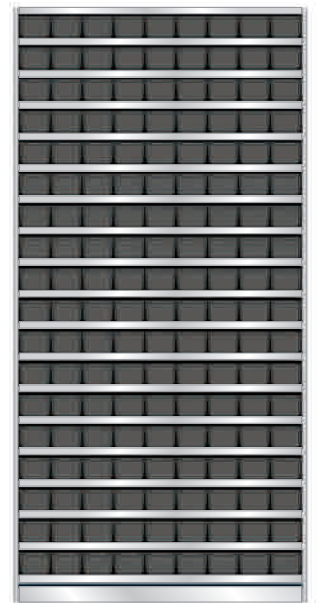

ASU 21C Shelving Unit Consists of

- ▶ 1 Set of ASUB 184C Shelving Body
- ▶ 19 Nos. Shelves - Art No.: ASUS 400C
- ▶ 9 Nos. PSB-401C Bins on each shelf
- ▶ Total 162 Nos. PSB-401C Bins

SHELVING SYSTEMS ORDERING CHART

Shelving Unit	Shelving Body			Kick Plate	Shelves		Panda Shelf Bins		System Udl
	Art No.	Roll Post	Back Plate		Art No.: ASUKPC	Art No.	No. Of Shelves	Art No.	
ASU-21C	ASUB-184C	2 Nos.	1 Set	1 No	ASUS 400C	19 Nos.	PSB-401C	162 Nos.	1140 Kgs.
ASU-22C	ASUB-184C	2 Nos.	1 Set	1 No	ASUS 400C	13 Nos.	PSB-402C	108 Nos.	780 Kgs.
ASU-23C	ASUB-184C	2 Nos.	1 Set	1 No	ASUS 400C	13 Nos.	PSB-403C	72 Nos.	780 Kgs.
ASU-24C	ASUB-184C	2 Nos.	1 Set	1 No	ASUS 400C	11 Nos.	PSB-404C	40 Nos.	660 Kgs.
ASU-25C	ASUB-184C	2 Nos.	1 Set	1 No	ASUS 400C	11 Nos.	PSB-405C	30 Nos.	660 Kgs.



PSB-401C BIN SIZE		
Length	Width	Height
415 mm	100 mm	60 mm



STANDARD COMBINATIONS

ASU 22C

SHELVING UNIT SIZE

Height	Width	Depth
1875 mm	900 mm	400 mm



ASU 22C Shelving Unit Consists of

- ▶ 1 Set of ASUB 184C Shelving Body
- ▶ 13 Nos. Shelves - Art No.: ASUS 400C
- ▶ 9 Nos. PSB-402C Bins on each shelf
- ▶ Total 108 Nos. PSB-402C Bins

ASU 23C

SHELVING UNIT SIZE

Height	Width	Depth
1875 mm	900 mm	400 mm



ASU 23C Shelving Unit Consists of

- ▶ 1 Set of ASUB -184C Shelving Body
- ▶ 13 Nos. Shelves - Art No.: ASUS- 400C
- ▶ 6 Nos. PSB-403C Bins on each shelf
- ▶ Total 72 Nos. PSB-403C Bins

ASU 24C

SHELVING UNIT SIZE

Height	Width	Depth
1875 mm	900 mm	400 mm



ASU 24C Shelving Unit Consists of

- ▶ 1 Set of ASUB 184C Shelving Body
- ▶ 11 Nos. Shelves - Art No.: ASUS 400C
- ▶ 4 Nos. PSB-404C Bins on each shelf
- ▶ Total 40 Nos. PSB-404C Bins

ASU 25C

SHELVING UNIT SIZE

Height	Width	Depth
1875 mm	900 mm	400 mm



ASU 25C Shelving Unit Consists of

- ▶ 1 Set of ASUB 184C Shelving Body
- ▶ 11 Nos. Shelves - Art No.: ASUS 400C
- ▶ 3 Nos. PSB-405C Bins on each shelf
- ▶ Total 30 Nos. PSB-405C Bins



PSB-402C BIN SIZE

Length	Width	Height
415 mm	100 mm	110 mm



PSB-403C BIN SIZE

Length	Width	Height
415 mm	150 mm	110 mm



PSB-404C BIN SIZE

Length	Width	Height
415 mm	220 mm	135 mm



PSB-405C BIN SIZE

Length	Width	Height
415 mm	300 mm	135 mm

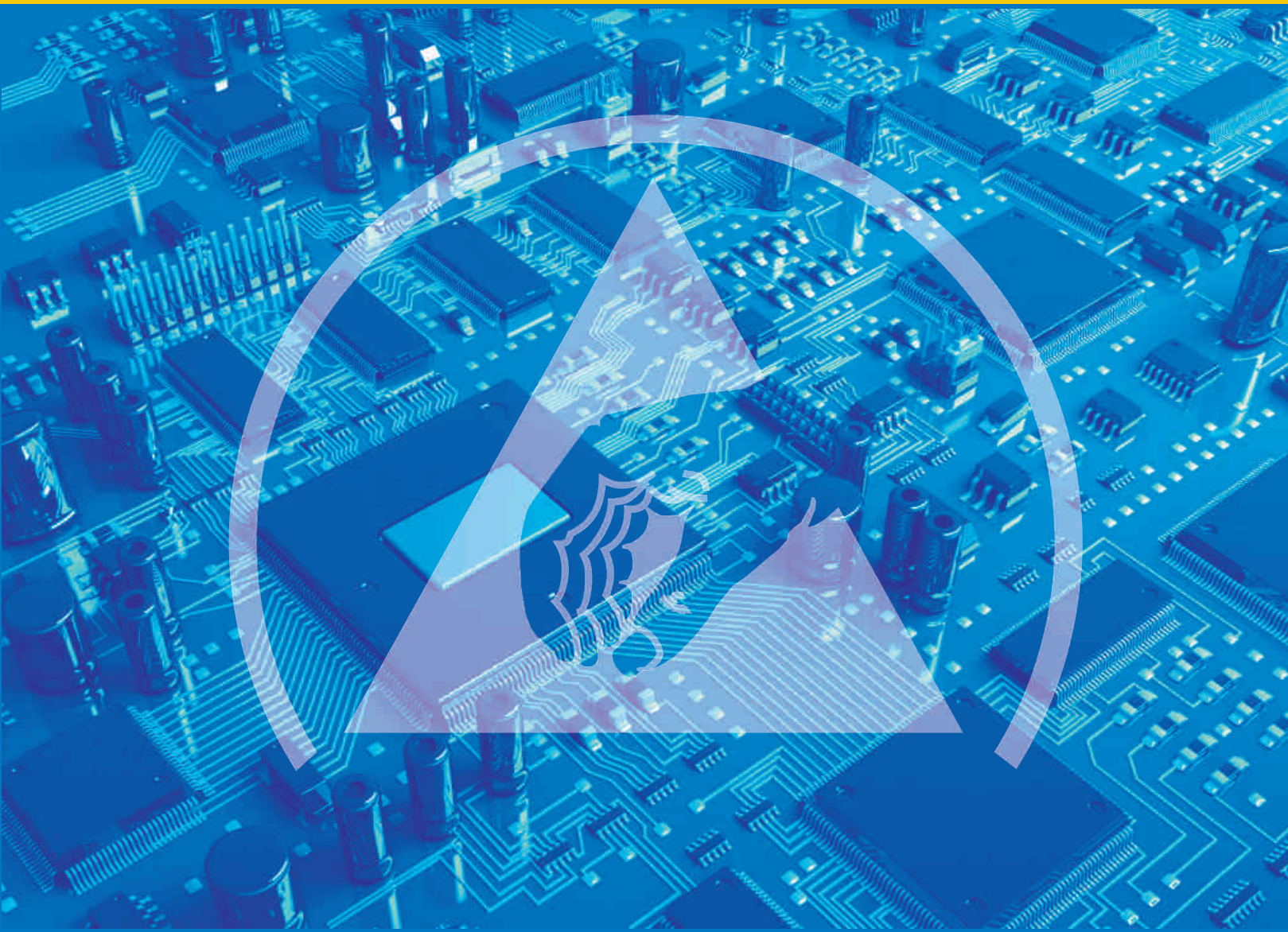

ALKON PLASTICS PVT. LTD.

Corporate off :-

801, Embassy Chamber, 3rd Road, Khar (W),
Mumbai - 400 052. INDIA.

Tel.: 0091- 22- 2604 2168 / 7567/ 9165 / 5370.

Fax.: 2605 1387 Email : sales@alkonplastics.com

www.alkonplastics.com

This Catalog should not be reproduced as it is covered under Copyright Act.

STOCKIST